

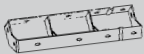







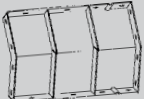
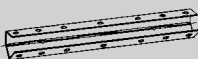
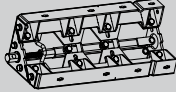
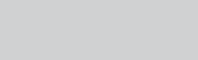

Teileliste

7

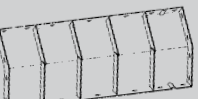
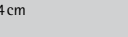
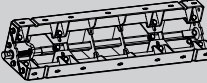
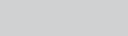
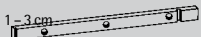
	Art.-Nr.	Bezeichnung	kg		Art.-Nr.	Bezeichnung	kg
		Raster Element				Kunststoffausgleich (PE)	
	100.001.1000	100x62,5 cm	27,50		100.011.1010	1 x 62,5 cm	0,43
	100.001.0750	75 x 62,5 cm	21,50		100.011.1020	2 x 62,5 cm	0,85
	100.001.0600	60 x 62,5 cm	16,90		100.011.1030	3 x 62,5 cm	1,28
	100.001.0500	50 x 62,5 cm	14,90		100.011.1040	4 x 62,5 cm	1,70
	100.001.0450	45 x 62,5 cm	12,30				
	100.001.0430	43 x 62,5 cm	11,90				
	100.001.0400	40 x 62,5 cm	11,30				
	100.001.0370	37 x 62,5 cm	10,80				
	100.001.0350	35 x 62,5 cm	10,50		100.012.0005	Ausgleichsblech mit Doppelsickung (für Breiten von 3/5/7 cm) 8 x 62,5 cm	3,25
	100.001.0330	33 x 62,5 cm	10,10				
	100.001.0300	30 x 62,5 cm	9,60				
	100.001.0250	25 x 62,5 cm	8,80				
	100.001.0240	24 x 62,5 cm	8,60				
	100.001.0200	20 x 62,5 cm	8,00				
	100.001.0150	15 x 62,5 cm	7,10				
100.001.0120	12 x 62,5 cm	6,60					
100.001.0100	10 x 62,5 cm	6,30					
		Ausgleichselement				Raster Element	
	100.003.0060	6 x 62,5 cm	5,00		101.001.1000	100 x 75 cm	30,00
100.003.0050	5 x 62,5 cm	4,70	101.001.0750		75 x 75 cm	24,10	
			101.001.0600		60 x 75 cm	19,10	
			101.001.0500		50 x 75 cm	16,80	
			101.001.0450		45 x 75 cm	14,10	
			101.001.0430		43 x 75 cm	13,70	
			101.001.0400		40 x 75 cm	13,10	
			101.001.0370		37 x 75 cm	12,50	
			101.001.0350		35 x 75 cm	12,10	
			101.001.0330		33 x 75 cm	11,70	
			101.001.0300		30 x 75 cm	11,10	
			101.001.0250		25 x 75 cm	10,10	
			101.001.0240		24 x 75 cm	9,90	
			101.001.0200		20 x 75 cm	9,10	
			101.001.0150		15 x 75 cm	8,10	
			101.001.0120	12 x 75 cm	7,50		
			101.001.0100	10 x 75 cm	7,10		
		Innenecke				Ausgleichselement	
	100.005.0150	15 x 15 x 62,5 cm	8,00	101.003.0060	6 x 75 cm	5,80	
100.005.0130	13 x 13 x 62,5 cm	7,50	101.003.0050	5 x 75 cm	5,40		
		Außenecke				Innenecke	
	100.006.0000	62,5 cm	3,20	101.005.0150	15 x 15 x 75 cm	9,60	
				101.005.0130	13 x 13 x 75 cm	9,00	
		Scharnierecke				Außenecke	
	100.007.0001	9,5 x 9,5 x 62,5 cm ohne Spannstellen- öffnungen	8,90	101.006.0000	75 cm	3,80	
100.007.0002	mit Spannstellen- öffnungen	8,90					
		Innenecke 135°				Scharnierecke	
	100.017.0002	12,5 x 12,5 x 62,5 cm	11,00	101.007.0001	9,5 x 9,5 x 75 cm ohne Spannstellen- öffnungen	8,90	
				101.007.0002	mit Spannstellen- öffnungen	8,90	
	100.017.0001	Außenecke 135° 25 x 25 x 62,5 cm	18,10				

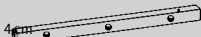
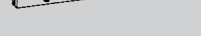
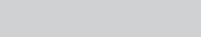
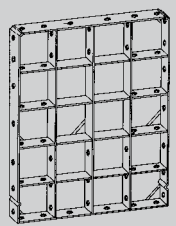

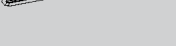
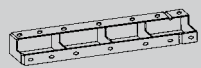







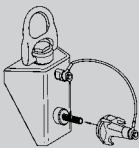
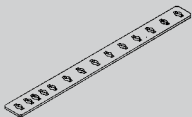
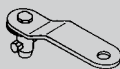

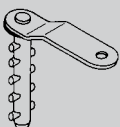
Teileliste

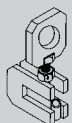
	Art.-Nr.	Bezeichnung	kg		Art.-Nr.	Bezeichnung	kg
	101.017.0002	Innenecke 135° 12,5 x 12,5 x 75 cm	12,60		103.006.0000	Außenecke 125 cm	6,40
	101.017.0001	Außenecke 135° 25 x 25 x 75 cm	20,50		103.007.0001	Scharnierecke 9,5 x 9,5 x 125 cm ohne Spannstellenöffnungen	17,70
	101.005.0251	Ausschal-Innenecke 25 x 25 x 75 cm	39,00		103.007.0002	mit Spannstellenöffnungen	17,70
	101.011.1010	Kunststoffausgleich (PE) 1 x 75 cm	0,50		103.017.0002	Innenecke 135° 12,5 x 12,5 x 125 cm	20,20
	101.011.1020	2 x 75 cm	1,00		103.017.0001	Außenecke 135° 25 x 25 x 125 cm	32,60
	101.011.1030	3 x 75 cm	1,50		103.005.0251	Ausschal-Innenecke 25 x 25 x 125 cm mit Doppelsickung	58,00
	101.011.1040	4 x 75 cm	2,00		103.011.1010	Kunststoffausgleich (PE) 1 x 125 cm	0,85
	101.012.0005	Ausgleichsblech mit Doppelsickung (für Breiten von 3/5/7 cm) 8 x 75 cm	3,90		103.011.1020	2 x 125 cm	1,70
		Raster Element			103.011.1030	3 x 125 cm	2,55
	103.001.1000	100 x 125 cm	49,50		103.011.1040	4 x 125 cm	3,45
	103.001.0750	75 x 125 cm	37,50			Ausgleichsblech mit Doppelsickung (für Breiten von 3/5/7 cm) 8 x 125 cm	6,50
	103.001.0600	60 x 125 cm	29,30			Raster Element	
	103.001.0500	50 x 125 cm	26,30		104.001.1000	100 x 150 cm	59,00
	103.001.0450	45 x 125 cm	21,60		104.001.0750	75 x 150 cm	44,50
	103.001.0430	43 x 125 cm	21,00		104.001.0600	60 x 150 cm	35,40
	103.001.0400	40 x 125 cm	20,10		104.001.0500	50 x 150 cm	31,40
	103.001.0370	37 x 125 cm	19,20		104.001.0450	45 x 150 cm	25,80
	103.001.0350	35 x 125 cm	18,60		104.001.0430	43 x 150 cm	25,00
	103.001.0330	33 x 125 cm	18,00		104.001.0400	40 x 150 cm	23,80
	103.001.0300	30 x 125 cm	17,10		104.001.0370	37 x 150 cm	22,80
	103.001.0250	25 x 125 cm	15,60		104.001.0350	35 x 150 cm	22,10
	103.001.0240	24 x 125 cm	15,30		104.001.0330	33 x 150 cm	21,40
	103.001.0200	20 x 125 cm	14,10		104.001.0300	30 x 150 cm	20,40
	103.001.0150	15 x 125 cm	12,60		104.001.0250	25 x 150 cm	18,70
	103.001.0120	12 x 125 cm	11,70		104.001.0240	24 x 150 cm	18,30
	103.001.0100	10 x 125 cm	11,10		104.001.0200	20 x 150 cm	16,90
		Ausgleichselement			104.001.0150	15 x 150 cm	15,20
	103.003.0060	6 x 125 cm	9,10		104.001.0120	12 x 150 cm	14,10
	103.003.0050	5 x 125 cm	8,60		104.001.0100	10 x 150 cm	13,40
		Innenecke					
	103.005.0150	15 x 15 x 125 cm	16,60				
	103.005.0130	13 x 13 x 125 cm	15,00				

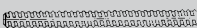
Teilleiste

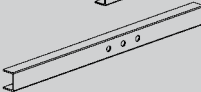
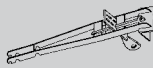
	Art.-Nr.	Bezeichnung	kg		Art.-Nr.	Bezeichnung	kg	
	104.003.0060	Ausgleichselement 6 x 150 cm	11,60		115.502.2000	GE Element 200 x 250 cm	258,00	
	104.003.0050	5 x 150 cm	11,00		115.502.1500	150 x 250 cm	217,00	
	104.005.0150	Innenecke 15 x 15 x 150 cm	19,20		116.502.2000	200 x 275 cm	280,00	
	104.005.0130	13 x 13 x 150 cm	18,00		116.502.1500	150 x 275 cm	243,00	
	104.006.0000	Außenecke 150 cm	7,60			113.502.2000	GE Aufstockelement 200 x 125 cm	140,00
	104.007.0001	Scharnierecke 9,5 x 9,5 x 150 cm ohne Spannstellen- öffnungen	21,20			113.502.1500	150 x 125 cm	117,00
104.007.0002	mit Spannstellen- öffnungen	21,20	114.502.2000			200 x 150 cm	165,00	
104.017.0002	Innenecke 135° 12,5 x 12,5 x 150 cm	24,10	114.502.1500			150 x 150 cm	139,00	
	104.017.0001	Außenecke 135° 25 x 25 x 150 cm	38,90			181.000.0024	GE/TTS Klammer verstellbar 0-5 cm	2,85
	104.005.0251	Ausschal-Innenecke 25 x 25 x 150 cm mit Doppelsickung	67,00			181.000.0027	GE/TTS Klammer (mit Spannkeil)	3,90
	104.011.1010	Kunststoffausgleich (PE) 1 x 150 cm	1,00			181.000.0004	Anhänge- und Klemmhalterung GE kpl. (ohne Steckbolzen)	4,30
	104.011.1020	2 x 150 cm	2,00				181.000.0043	Kombigurt 190 cm
	104.011.1030	3 x 150 cm	3,00		181.000.0044		Gurtspanner GE kpl.	3,50
	104.011.1040	4 x 150 cm	4,00			189.001.0031	Gurthalterung 100 Klemmlänge 10 cm	0,50
	104.012.0005	Ausgleichsblech mit Doppelsickung (für Breiten von 3/5/7 cm) 8 x 150 cm	7,80	189.001.0032		Gurthalterung 240 Klemmlänge 24 cm	0,70	

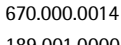
Teileliste

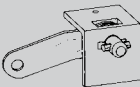
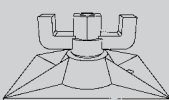
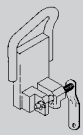
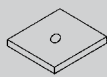
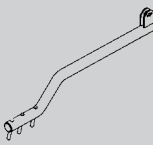
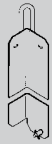
	Art.-Nr.	Bezeichnung	kg		Art.-Nr.	Bezeichnung	kg
	181.000.0028	Kranbügel GE Tragfähigkeit 1.200 kg	6,50		189.001.0020	Distanzlasche 6- 50 cm	1,50
	189.001.0100	Verbindungsbolzen	0,19		189.001.0021	50- 120 cm	3,50
	189.001.0105	Verbindungsbolzen 5 Stifte	0,30		189.001.0086	Spannstabhalter	0,75
	189.001.0079	Elementzwinge	0,85		189.001.0071	Traversenhalterung	0,60
	189.006.0650	DW 15 x 65 cm	0,90		189.001.0066	Quertraverse 35 cm	1,50
Darf nicht geschweißt werden.	189.006.1000	DW 15 x 100 cm	1,40		189.001.0067	85 cm	4,00
	189.006.1350	DW 15 x 135 cm	1,85		670.000.0013	Klemmbügel mit Keil kpl. bestehend aus:	2,00
	189.006.1500	DW 15 x 150 cm	2,10		670.000.0014	Klemmbügel	0,55
	189.001.0001	Flügelmutter DW 15	0,46		189.001.0000	Keil	0,16
	189.001.0002	Sechskantmutter DW 15	0,20		189.001.0017	Anschlagwinkel für 21 mm Schalhaut	0,45
	189.001.0059	Kugelenkplatte DW 15 10x14 cm (Neigung max. 12°)	1,10		189.002.0008	Krananhängung KA Tragfähigkeit 600 kg	4,00
	189.001.0060	Gegenplatte 12 x 12 x 1,5 cm ø 21 mm	1,60		189.003.0000	Montagehebel	3,90
	180.000.0012	für 12 gleich große Elemente	4,70		280.000.0042	für 20 gleich große Elemente	8,00

Teileliste

Art.-Nr. Bezeichnung kg

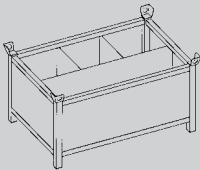
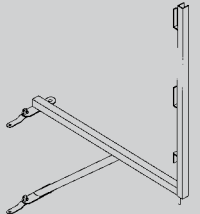
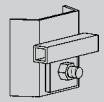
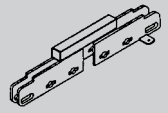
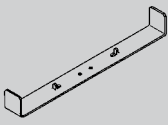
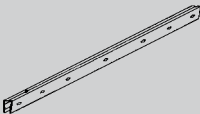
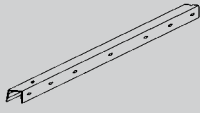
	189.002.0003	Transportbox, feuerverzinkt 120 x 80 x 61 cm	93,50
	189.004.0013	Laufkonsole kpl. 90 cm	11,00
	189.004.0010	120 cm	14,50
	181.000.0049	Stirnabstellungshalter GE kpl.	3,10
	181.000.0084	Verbindungsbügel für Schalhaut 21 mm	2,45
		Fundamentspanner	
	180.001.0200	20 cm	0,28
	180.001.0250	25 cm	0,32
	180.001.0300	30 cm	0,35
	180.001.0350	35 cm	0,38
	180.001.0400	40 cm	0,42
	180.001.0450	45 cm	0,44
	180.001.0500	50 cm	0,48
180.001.0600	60 cm	0,54	
		Vieleckausgleichs- element innen	
	100.014.0001	4,66 x 62,5 cm	2,90
	101.014.0001	4,66 x 75 cm	3,40
	103.014.0001	4,66 x 125 cm	5,80
104.014.0001	4,66 x 150 cm	6,90	
		Vieleckausgleichs- element außen	
	100.014.0002	9,02 x 62,5 cm	3,20
	101.014.0002	9,02 x 75 cm	3,90
	103.014.0002	9,02 x 125 cm	6,50
	104.014.0002	9,02 x 150 cm	7,80

